

Primary 3
English Language

Listening

2

Instructions:

學生須知：

1. There are 8 pages in this Question-Answer Booklet. Answer all questions.
本卷共有 8 頁，全部題目均須作答。
2. Time allowed is about 20 minutes.
評估時限約為 20 分鐘。
3. Write your Name, Class and Class Number in the boxes below.
在下面的方格內填寫你的姓名、班別及班號。

Instructions for answering questions:

作答說明：

Multiple Choice Questions — Blacken the circle next to the correct answer with an **HB pencil**. For example:

選擇題 — 選出正確的答案，並用 **HB** 鉛筆把該選項的圓圈塗黑和塗滿，如：

- A. or A. B.
 B. or C. D.
 C. or C. D.
 D.

Part	Marks
1	/ 8
2	/ 11

Total: / 19
Score for achieving BC: 13

Name
學生姓名

Class
班別 3

Class No.
班號

Part 1



Track 03

Macy talks to her brother, Andy, about eating out tonight.

Listen to the conversation.

Choose the best answer by blackening the circle.

1. Macy and Andy will meet at _____.

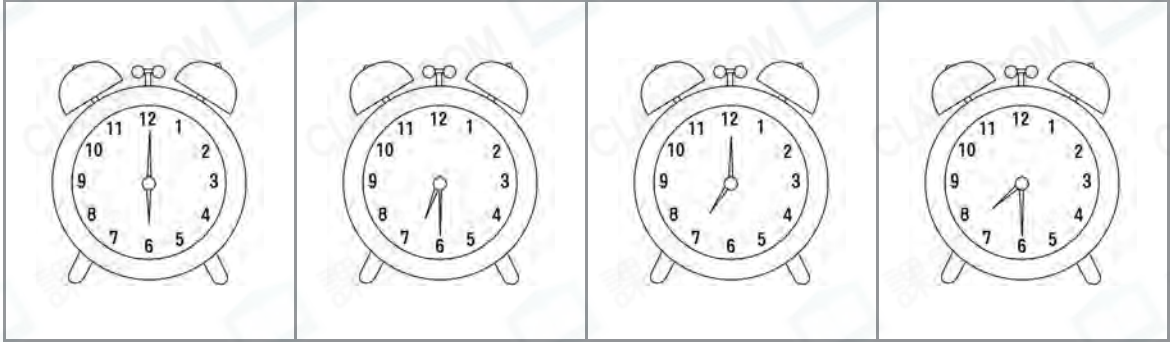

A.

B.

C.

D.

2. Where will Macy and Andy meet?

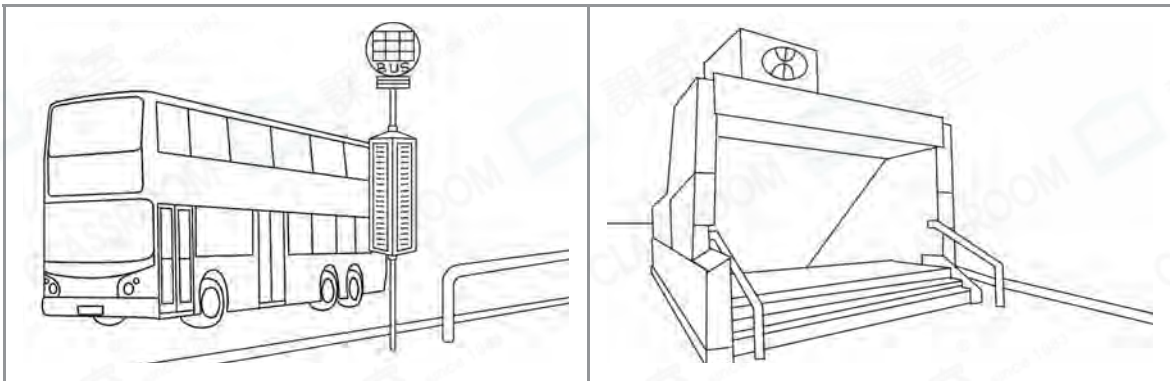

A.

B.

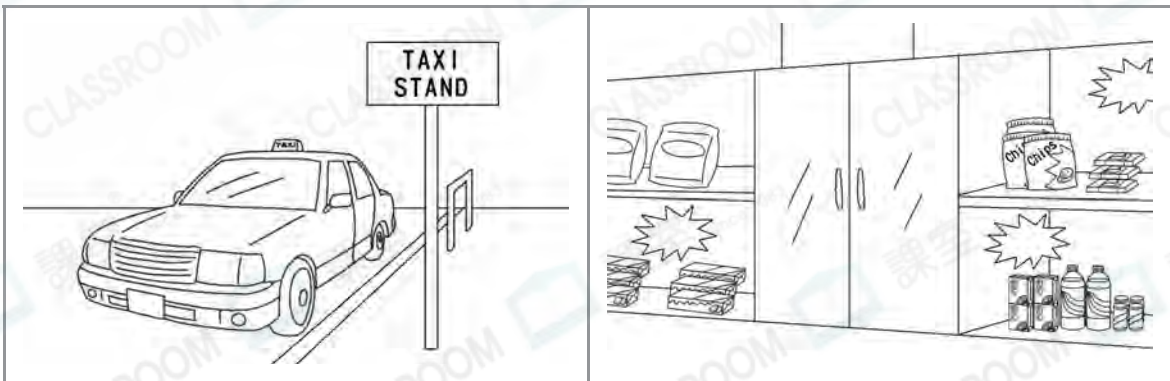

C.

D.

Please do not write in the margin.
請勿在此書寫。

3. How did Macy's and Andy's mother feel about Lee's Restaurant?



A.



B.



C.



D.

4. Macy does **NOT** want to go to Bobo Café because _____.

- A. the waiters are not friendly
- B. it is not near their home
- C. the food is expensive
- D. the food is not good

5. Yummy House serves _____ food.

- A. Italian
- B. Indian
- C. Japanese
- D. Chinese

Please do not write in the margin.
請勿在此書寫。

6. What kind of food does Andy like in Yummy House?

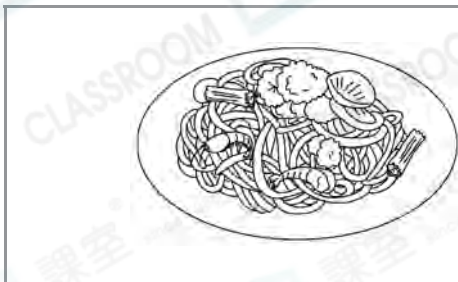

A.

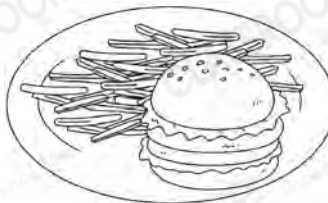

B.

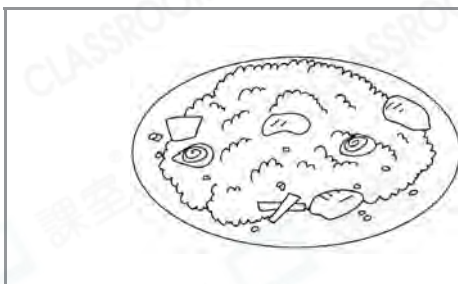

C.

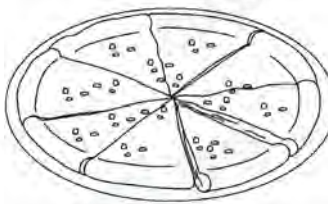

D.

7. Macy and Andy will invite _____ to join the dinner.

A. Polly and Sarah

B. Paula and Sally

C. Paul and Susan

D. Pauline and Sharon

8. What will Macy buy?

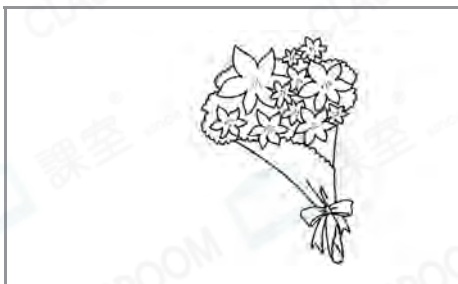

A.



B.

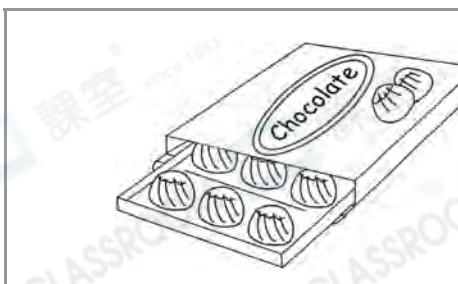

C.

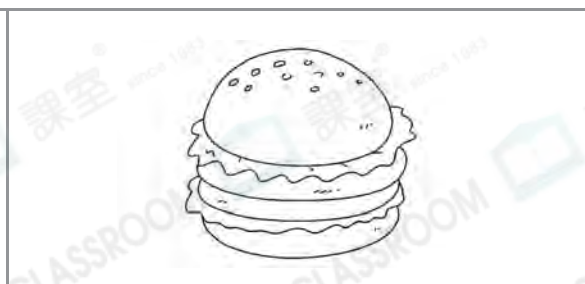

D.

Please do not write in the margin.
請勿在此書寫。

Part 2



Track 04

Macy and Brian are at a shopping mall.

Listen to the conversation.

Choose the best answer by blackening the circle.

1. How does Macy feel when she sees the poster of the film?

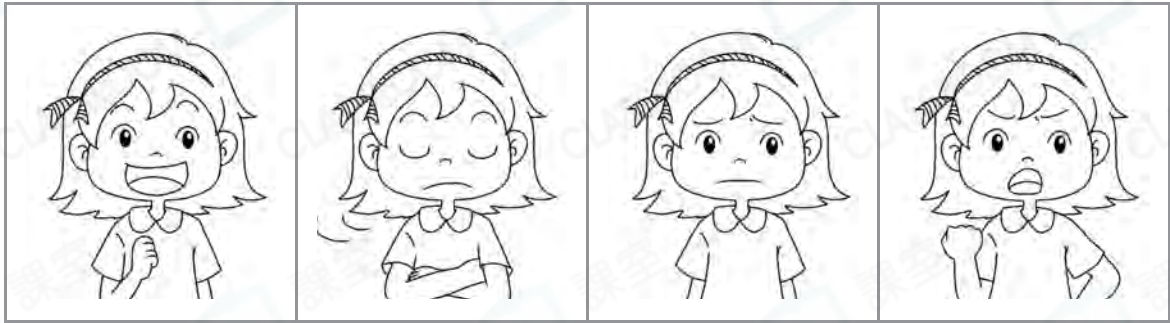

A.

B.

C.

D.

2. Which of the following is the poster they see?

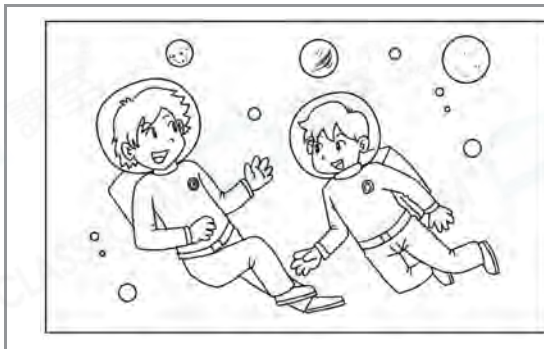

A.

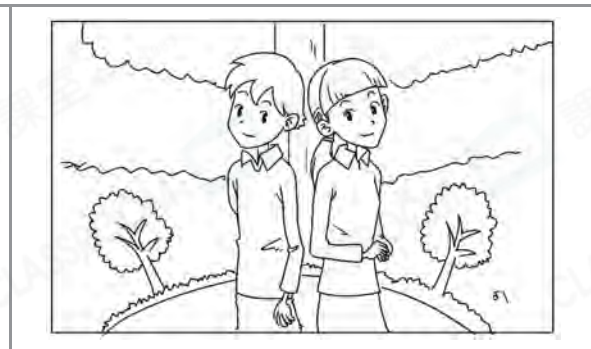

B.

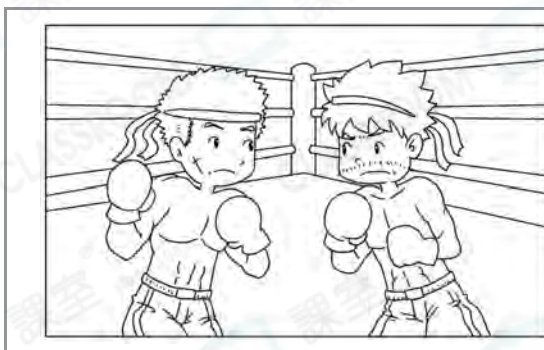

C.

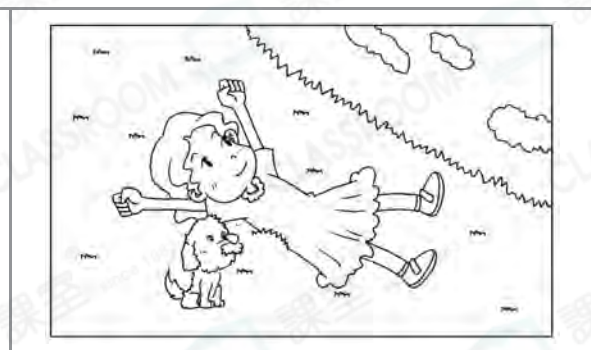

D.

Please do not write in the margin.
請勿在此書寫。

3. The member of staff says 'Please wait' because he _____.



- A. needs a break
- B. is busy
- C. needs some time to get the answer
- D. cannot hear Macy clearly

4. How does Macy feel after talking to the member of staff?



A.

B.

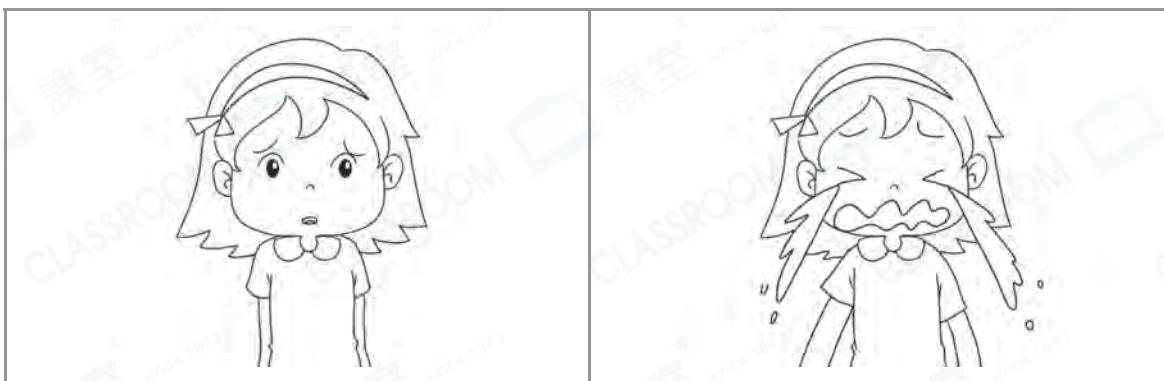

C.

D.

5. Brian asks Macy 'Are you alright?' because she _____.

- A. can't watch the film she wants to watch
- B. can't eat the food she wants to eat
- C. left her purse at her home
- D. does not have any money to buy the film tickets

Please do not write in the margin.
請勿在此書寫。

6. Where will they buy the fries?



A.

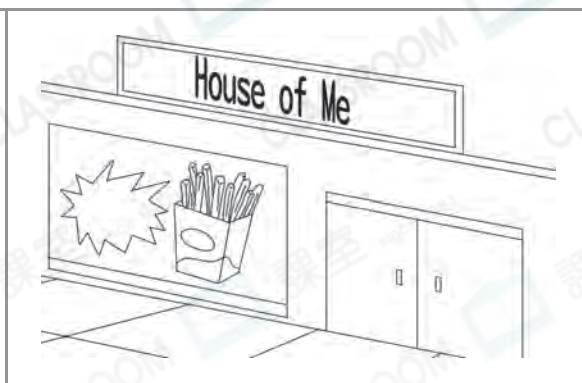

B.

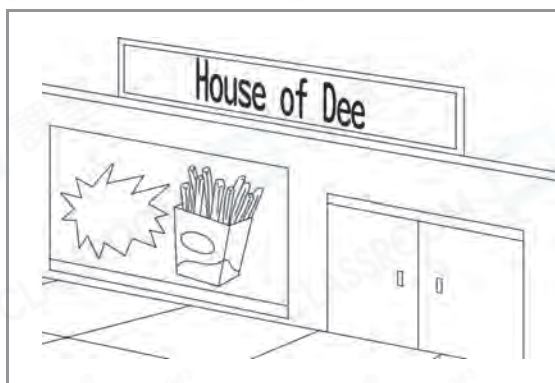

C.

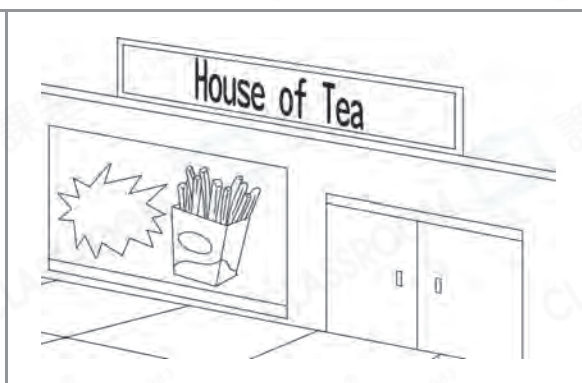

D.

7. Which flavour of sauce will they choose?



- A. tomato
- B. beef
- C. black pepper
- D. onion

8. How much are the fries?



- A. \$5
- B. \$10
- C. \$20
- D. \$25

Please do not write in the margin.
請勿在此書寫。

9. Why does Brian NOT buy both robots?

- A. Macy does not allow him to do so.
- B. His mother does not allow him to do so.
- C. One of the robots does not look nice.
- D. He does not have enough money.

10. Which robot does Brian choose?

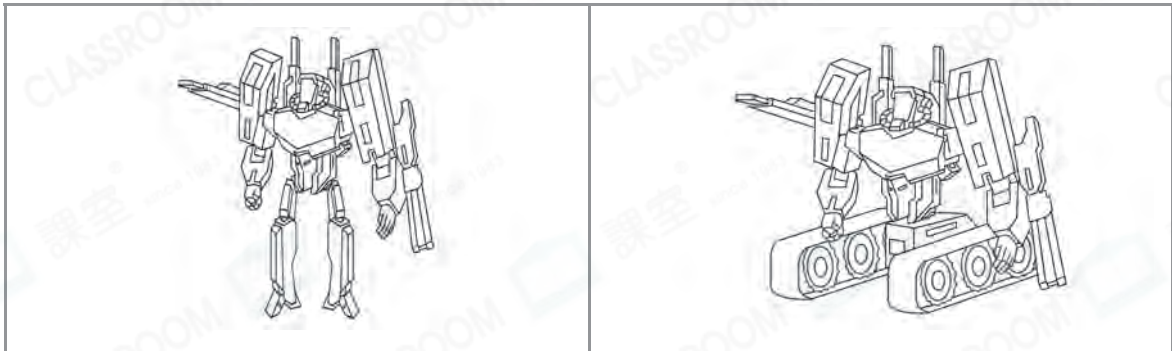

A.

B.

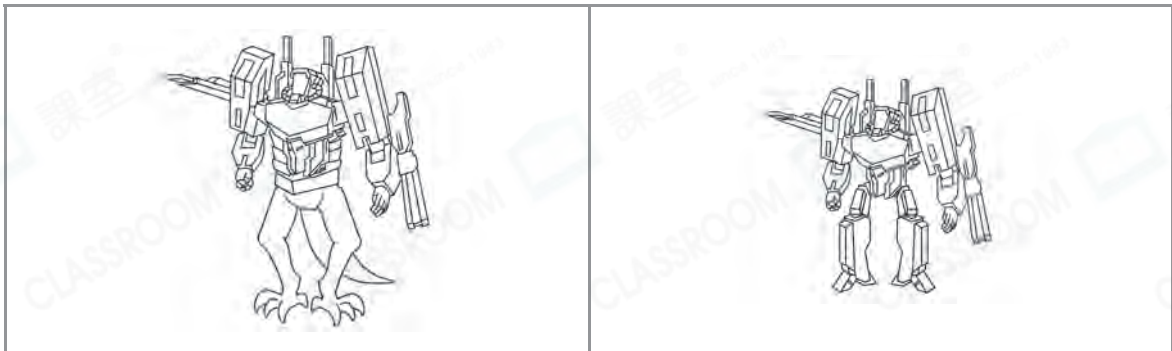

C.

D.

11. What is the time now?

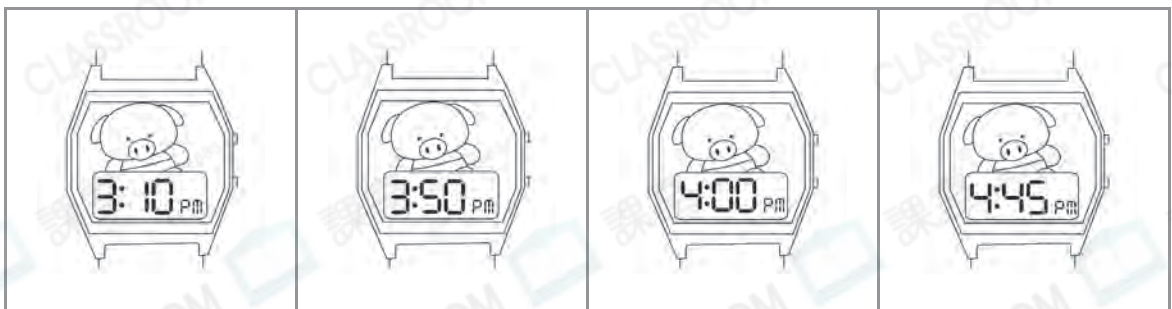

A.

B.

C.

D.

END OF PAPER

Please do not write in the margin.
請勿在此書寫。