

Primary 6  
English Language

Reading and Writing

7

**Instructions:**

學生須知：

1. There are 16 pages in this Question-Answer Booklet. Answer all questions.  
本卷共有 16 頁，全部題目均須作答。
2. Time allowed is 50 minutes.  
評估時限為 50 分鐘。
3. Write your Name, Class and Class Number in the boxes below.  
在下面的方格內填寫你的姓名、班別及班號。

**Instructions for answering questions:**

作答說明：

**Multiple Choice Questions** — Blacken the circle next to the correct answer with an **HB pencil**. For example:

選擇題 — 選出正確的答案，並用 **HB** 鉛筆把該選項的圓圈塗黑和塗滿，如：

- A.                      or                      ● A.                      ○ B.  
○ B.                      or                      ○ C.                      ○ D.  
○ C.                      or                      ○ C.                      ○ D.  
○ D.

**Other Questions** — Write your answers in the spaces provided.

其他題目 — 在適當的位置內填寫答案

Part	Marks
1	/ 8
2	/ 8
3	/ 9
4	/ 6
5 (Writing)	/ 7

Total:  / 38  
Score for achieving BC: 21

Name   
學生姓名

Class     
班別 6

Class No.    
班號

此格只許填寫一個大楷英文字母  
Write one capital letter in this box.

## Part 1

*Matt is checking his e-mail in the computer room.*

Read the e-mail.

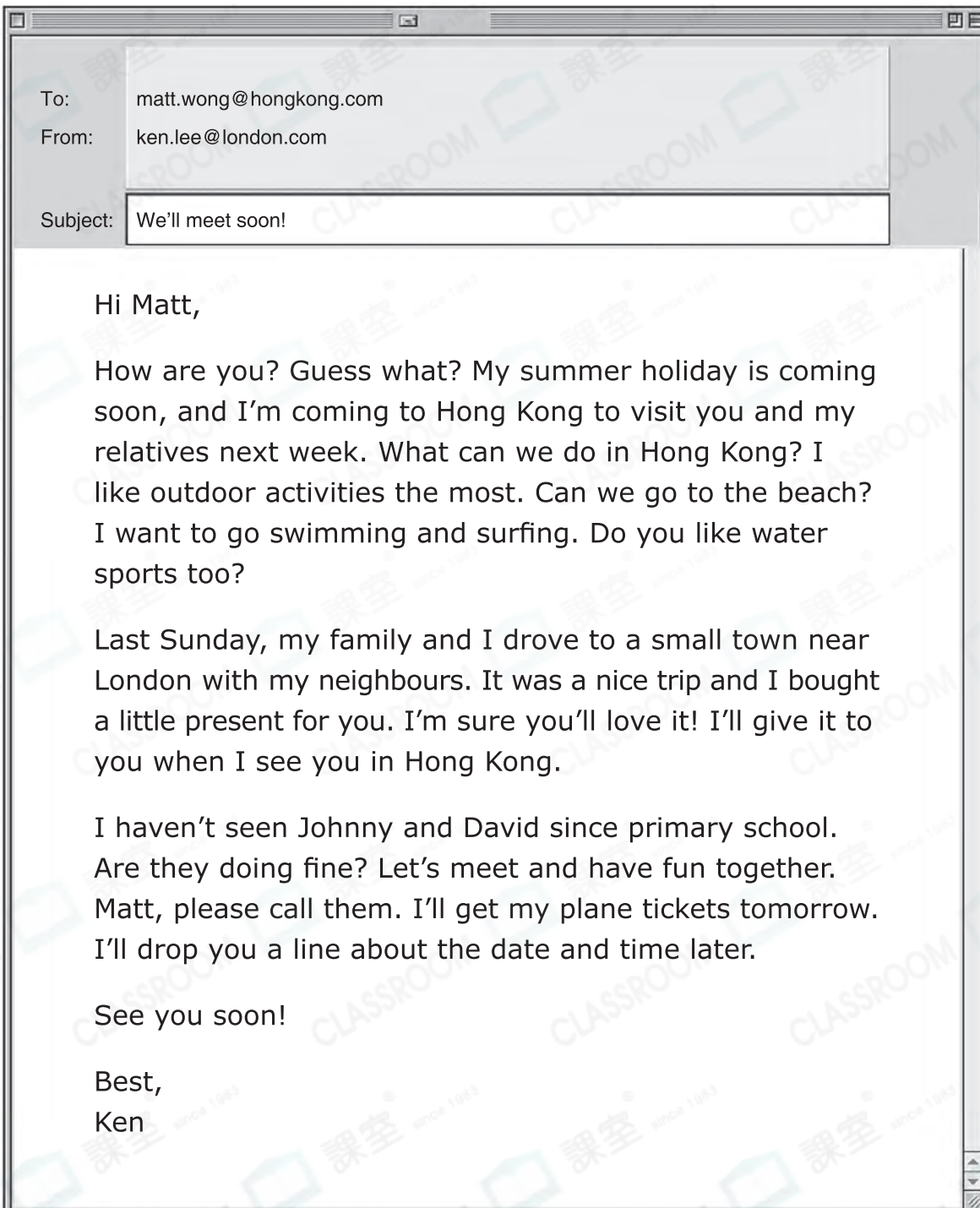

To: matt.wong@hongkong.com  
From: ken.lee@london.com  
Subject: We'll meet soon!

Hi Matt,

How are you? Guess what? My summer holiday is coming soon, and I'm coming to Hong Kong to visit you and my relatives next week. What can we do in Hong Kong? I like outdoor activities the most. Can we go to the beach? I want to go swimming and surfing. Do you like water sports too?

Last Sunday, my family and I drove to a small town near London with my neighbours. It was a nice trip and I bought a little present for you. I'm sure you'll love it! I'll give it to you when I see you in Hong Kong.

I haven't seen Johnny and David since primary school. Are they doing fine? Let's meet and have fun together. Matt, please call them. I'll get my plane tickets tomorrow. I'll drop you a line about the date and time later.

See you soon!

Best,  
Ken

5

10

15

Please do not write in the margin.  
請勿在此書寫。

Choose the best answer by blackening the circle.

1. Where is Ken now?



- A. in Hong Kong
- B. in America
- C. in England
- D. in Thailand

2. Ken is likely to like \_\_\_\_\_ weather.



- A. sunny
- B. cold
- C. rainy
- D. cloudy

3. What does Ken like to do?

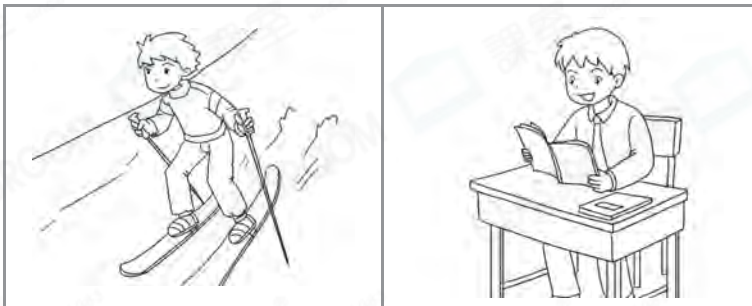

A.

B.



C.

D.

Please do not write in the margin.  
請勿在此書寫。

4. Read paragraph 2. What is another word for ‘a little present’?

- A. a prize
- B. a reward
- C. a souvenir
- D. a treasure

5. Read line 13: Are they doing fine?

The word ‘they’ refers to \_\_\_\_\_.

- A. Matt and David
- B. Matt and Ken
- C. David and Johnny
- D. Matt, Johnny and David

6. Who are Johnny and David?

They are Ken and Matt’s \_\_\_\_\_.

- A. relatives
- B. friends from primary school
- C. neighbours
- D. friends from the kindergarten

7. Which of the following are true about Ken?

- 1) He misses his primary school.
- 2) He does not live in Hong Kong.
- 3) He misses his childhood friends.
- 4) He will bring a present to Matt.

- A. 1, 2 and 3
- B. 2, 3 and 4
- C. 1, 3 and 4
- D. 1, 2 and 4

Please do not write in the margin.  
請勿在此書寫。

8. In line 15, what does the word 'drop' mean?

**drop** *verb*

1. to stop doing something  
*'I'm going to drop painting and do pottery instead.'*
2. to send  
*'He dropped me a message on my blog.'*
3. to fall  
*'Tears dropped down from her face.'*
4. to let something fall  
*'Mum dropped the keys onto the table.'*

- A. 1
- B. 2
- C. 3
- D. 4

Please do not write in the margin.  
請勿在此書寫。

**Part 2**

*Matt is reading a poem in his English lesson.*

Read the poem.

The weather is warm, the weather is wet.  
Light rain falls down during this time.  
Plants begin to grow and they look fine.  
Beautiful flowers all in a line.

Sea waves dance and shimmer.  
You can see all the swimmers  
Enjoying themselves at the beach  
Until the moon shines like a peach.

Cool wind blows, dry wind blows.  
Let's enjoy a meal in the countryside.  
Going for a long walk is also fun.  
However, we have less time to see Mr Sun.

Cold wind blows in this season.  
Friends start to send their wishes.  
This day cheers up me and you.  
It is Christmas so don't feel blue.

5

10

15

Please do not write in the margin.  
請勿在此書寫。

Choose the best answer by blackening the circle.

1. What is the main idea of the poem?

- A. festivals
- B. favourite weather
- C. seasons
- D. different activities

2. In line 3, 'they' refers to \_\_\_\_\_.

- A. raindrops
- B. plants
- C. beautiful flowers
- D. sea waves

3. In lines 6 – 8, when do the swimmers leave the beach?

- A. in the morning
- B. at noon
- C. in the afternoon
- D. at night

4. In lines 10 – 11, what does the writer like to do?

He likes to \_\_\_\_\_.

(You can choose more than one answer.)

- A. have a picnic
- B. go camping
- C. go swimming
- D. go hiking

Please do not write in the margin.  
請勿在此書寫。

5. In line 12, what does the writer mean?

- A. The weather is drier.
- B. The weather is warmer.
- C. The daytime is longer.
- D. The daytime is shorter.

6. In line 16, 'blue' means \_\_\_\_\_.



- A. excited
- B. happy
- C. surprised
- D. sad

7. In the poem, 'Sun' rhymes with 'fun'. Which pair of words rhymes?

- A. 'wave' and 'wind'
- B. 'good' and 'fine'
- C. 'you' and 'blue'
- D. 'cheers' and 'blows'

Please do not write in the margin.  
請勿在此書寫。

### Part 3

*Matt is reading some information on the noticeboard.*

Read the information.

#### For the Anniversary of the Handover of Hong Kong to China

The Hong Kong Tourism Board  
Presents

## ***IN THE CITY***

*In the 1950s...*

*The play is about a young woman who comes to Hong Kong to look for her long-lost son. She knows that her son is now living and working in Hong Kong. All she has is a photo of her son when he was five years old. She soon discovers more about Hong Kong. During her search for her son, she settles down in the city. She falls in love with Hong Kong. Will she ever find her son in this bustling city with so many people?*

***In The City*** is a warm family love story set in Hong Kong. You will love seeing places in Hong Kong in the past!

**Starring:** *Maria Leung, Waris Chan and Tony Lee*

**Time** : 8:30 pm  
**Date** : 28 – 30 June  
**Venue** : Hong Kong Arts Centre  
**Tickets** : Adults \$180  
Students \$90\*

\*For FULL-TIME students only

Please do not write in the margin.  
請勿在此書寫。

Choose the best answer by blackening the circle.

1. What is Matt reading?

- A. a play
- B. a poster
- C. a story
- D. a notice

2. Why does the young woman come to Hong Kong?

She comes to \_\_\_\_\_.

- A. study the history of Hong Kong
- B. find a good job
- C. live in a better place
- D. find her son

3. A 'bustling city' means a \_\_\_\_\_.

- A. rich city
- B. dirty city
- C. big city
- D. busy city

4. What may happen to the young woman in the end?



- A. She becomes very sick and dies.
- B. She lives happily with her son.
- C. She falls in love with a young man.
- D. She goes back to mainland China alone.

Please do not write in the margin.  
請勿在此書寫。

5. Matt is in Primary 6. What must he bring to buy himself a half-price ticket?

He must bring \_\_\_\_\_.

- A. an Octopus card
- B. a student card
- C. an invitation card
- D. a credit card

6. How many performance(s) are there?

- A. 1
- B. 2
- C. 3
- D. 4

7. The play is to \_\_\_\_\_.

- A. raise money for the Hong Kong Tourism Board
- B. tell people about the history of China
- C. raise money for the Hong Kong Arts Centre
- D. celebrate the handover of Hong Kong to China

8. The play is about \_\_\_\_\_.

(You can choose more than one answer.)

- A. romance
- B. family love
- C. Hong Kong today
- D. Hong Kong in the past

Please do not write in the margin.  
請勿在此書寫。

## Part 4

Matt is reading some information in a book.

Read the information.

### Lovely Sounds

#### Flutes

Flutes are silver instruments. They are held horizontally just under the mouth. People blow air across the mouthpiece and press the finger keys of this type of instrument to produce sounds. Early flutes were made from animal bones that were at least 37,000 years old.

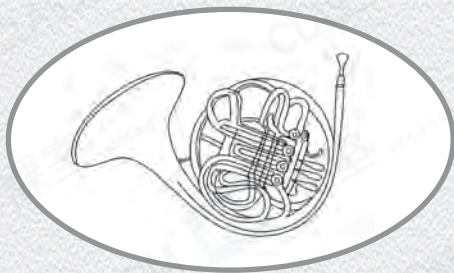

#### French Horns

Modern French horns were invented based on early hunting horns. Horns were first used as musical instruments during the 16<sup>th</sup> century.

#### Saxophones

Saxophones are relatively young instruments. They were exhibited to the world for the first time in 1841.

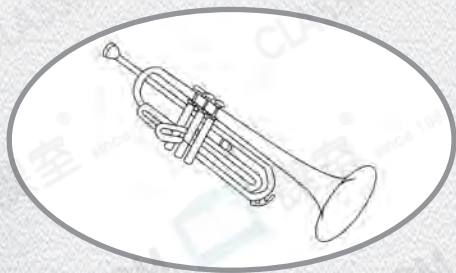

#### Trumpets

Trumpets are one of the earliest instruments. The first trumpet was very different from the modern trumpet. In the past, people used hollow materials like animal horns as trumpets.

Please do not write in the margin.  
請勿在此書寫。

Choose the best answer by blackening the circle.

1. Matt is reading a book about \_\_\_\_\_.
  - A. transport
  - B. musical instruments
  - C. housing
  - D. animals
  
2. Which of the following is true about saxophones?
  - A. They are very young compared to other instruments.
  - B. They were invented in 1842.
  - C. They were shown to only a few people in 1841.
  - D. They are made from animal parts.
  
3. Which of the following is true about French horns?
  - A. They were not used to play music after the 16<sup>th</sup> century.
  - B. They were invented in recent years.
  - C. They were developed from early hunting horns.
  - D. They are not musical instruments now.
  
4. Which of the following is **NOT** true about flutes?
  - A. They are put under the mouth when they are used.
  - B. They were made from animal parts in the past.
  - C. They can produce sounds when people blow air across the mouthpiece.
  - D. They can produce different sounds without people pressing the keys.

Please do not write in the margin.  
請勿在此書寫。

5. Which of the following could be useful for hunting in the past?

- A. saxophones
- B. French horns
- C. trumpets
- D. flutes

6. Which of the following is an example of an early trumpet?

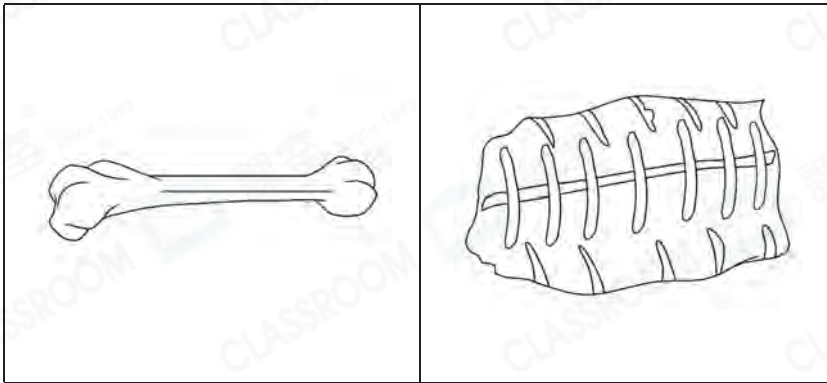

A.

B.

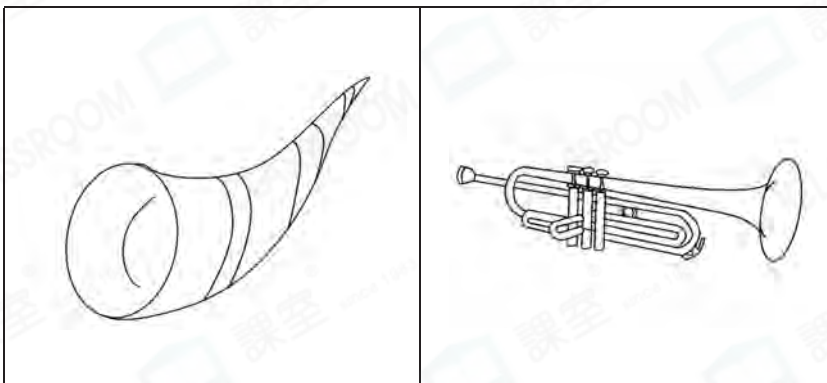

C.

D.

Please do not write in the margin.  
請勿在此書寫。

**Part 5**

*You are writing an article for the school magazine about winning book coupons in a writing competition.*

Write the article in 80 words. You may use your own ideas or the following questions and pictures for your composition.

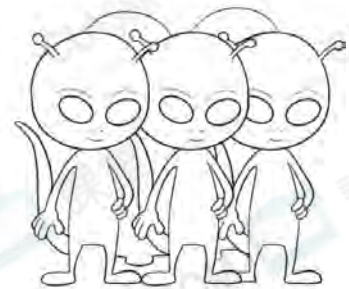
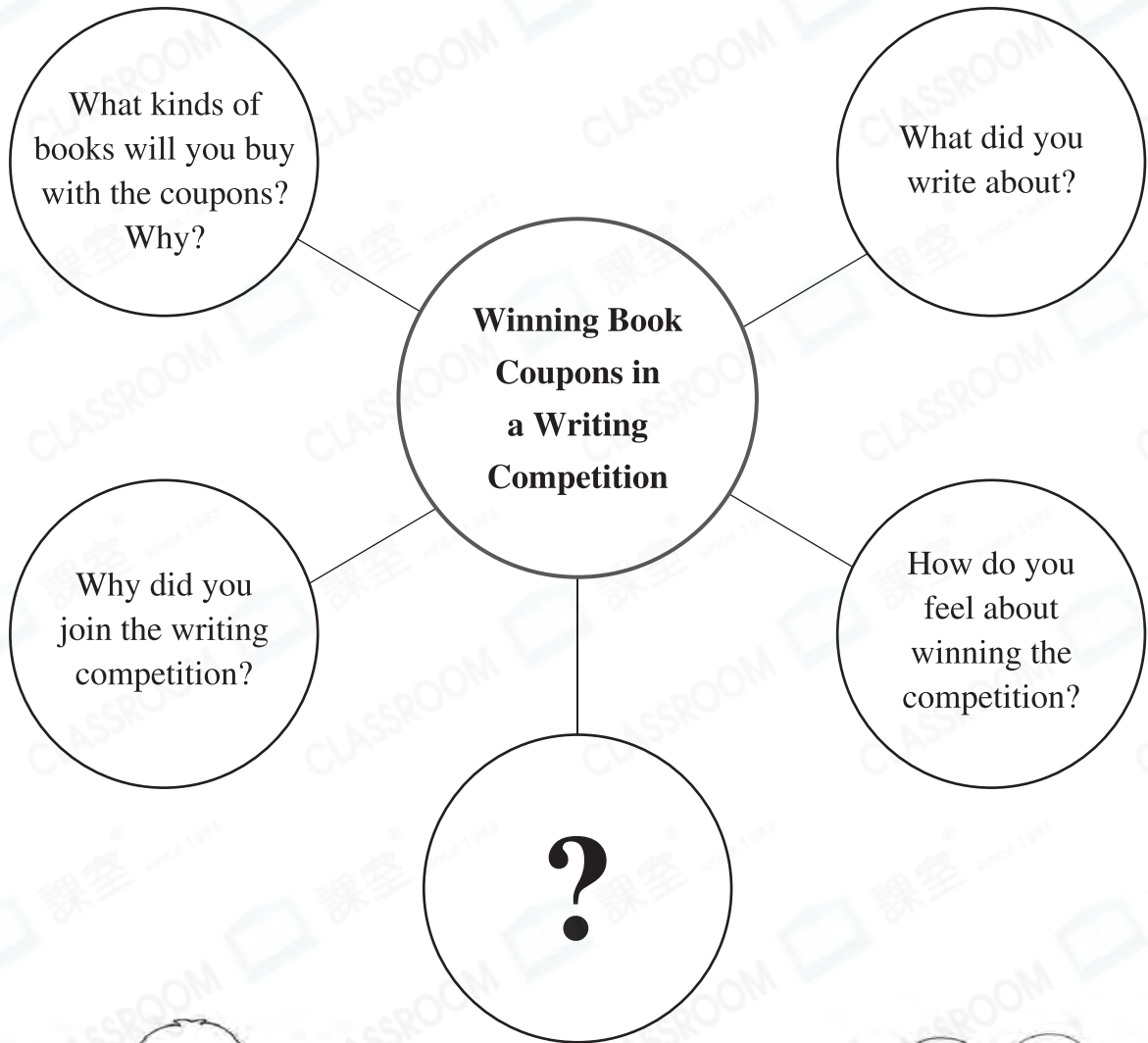

Please do not write in the margin.  
請勿在此書寫。

