



# CONTENTS

# 1B

Unit	Topic	Page	You've Scored
1	Toys We Share <span>Table</span>	2	/ 17
2	Beautiful Clothes <span>Picture Description</span>	4	/ 16
<b>Upgrade Your Listening 1</b>		6	/ 13
3	Fun in the Park <span>Picture Description</span>	8	/ 20
4	Lovely Animals <span>Table</span>	10	/ 21
<b>Upgrade Your Listening 2</b> <span>Skills for Exam</span>		12	/ 13
5	Look! We Are Having Fun! <span>Picture Description</span>	14	/ 17
6	Enjoy Our Free Time <span>Table</span>	16	/ 15
<b>Upgrade Your Listening 3</b> <span>Skills for Exam</span>		18	/ 15
7	Our Feelings <span>Table</span>	20	/ 17
8	Love My Body <span>Picture Description</span>	22	/ 20
<b>Upgrade Your Listening 4</b>		24	/ 18
Revision 1		26	/ 11
Revision 2		28	/ 10
Revision 3		30	/ 14
<b>Smart Vocabulary</b>		32	



The answer key and tapescripts can be found in the separate booklet.

**TEACHERS 教師專區**  
CLASSROOM CENTRE

Teachers can get access to the test bank on the following website:  
[www.classroom.com.hk/ptc](http://www.classroom.com.hk/ptc)  
(For school orders only; activation needed)



# 1

# Toys We Share



**A** Write the correct letters in the boxes.

- A. a toy gun    B. a toy train    C. a ball  
D. a model car    E. a teddy bear

1

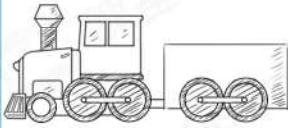

**B**

2



**E**

3







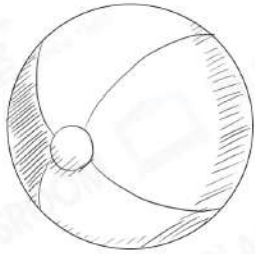





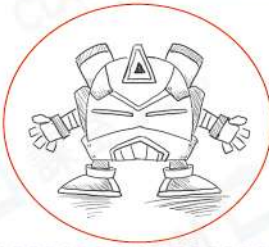

**A**

4



**C**

**B** Listen and circle the correct answers.

Name	Favourite Toy		
 David			
 Amy			
 Alan			

Rate your work:  
(Please circle)



You've scored



Date: \_\_\_\_\_

/17

Table

02 **C** Listen and put a tick '✓' for the correct colours and names.

1

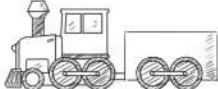
Toy	Colour				Name
	red	yellow	blue	green	
	✓			✓	<input checked="" type="checkbox"/> Jenny <input type="checkbox"/> Penny
		✓	✓		<input type="checkbox"/> Tim <input checked="" type="checkbox"/> Tom
		✓		✓	<input checked="" type="checkbox"/> Ben <input type="checkbox"/> Ken

Marking:  
Please note that 1 mark will be scored for the name of each child and another 2 marks will be scored for the colours of each toy. In other words, students have to get all the colours of each toy correct to get the 2 marks.

Blacken ● the circle for the correct answer.

Which toy makes Mum happy?



A.

B.

C.

D.



# 2

# Beautiful Clothes



03 **A** Listen and fill in the blanks with the correct letters.

A. Brother B. Dad C. Sister D. Grandma E. Mum



C



A



B



D

04 **B** Listen and put a tick '✓' or a cross '✗' in the boxes.



Macy



Gary

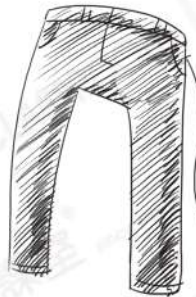

Danny



Jim



Kate



Rate your work:  
(Please circle)



You've scored

Date: \_\_\_\_\_

/16

Picture Description



Listen and write the correct words in the boxes.

2

black orange brown grey  
purple blue pink

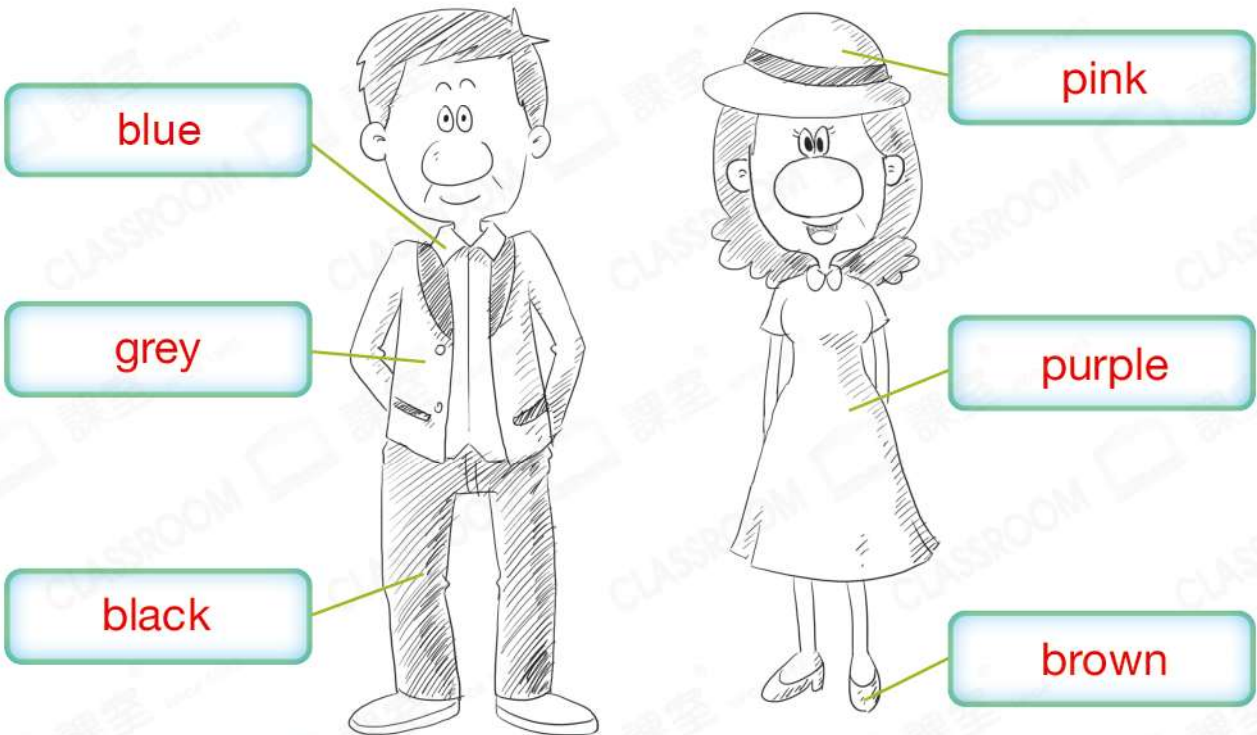

Circle the correct picture.

Where are Mum and Dad going?

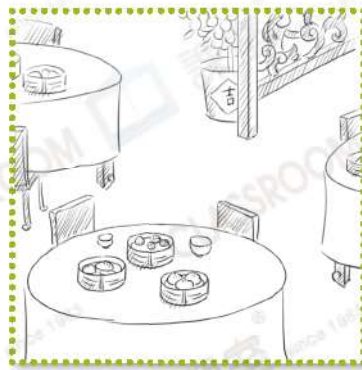

# Upgrade Your Listening



Listen



06 **A** Listen and circle the words that you hear.

1. bed head red leg
2. pot hot put pet
3. ten hen pen men
4. sick socks six sing
5. dog dot board ball

07 **B** Listen and put a tick '✓' in the correct boxes.

## Presents for Good Children

1. Give a toy bear to

Mary

Marie

Maria

2. Give a toy

car

cat to Harry.

cart

3. Give a green and yellow

ball

doll to Alice.

dog



Rate your work:  
(Please circle)



You've scored

Date: \_\_\_\_\_

/13



**C** The Chan family is going shopping. Listen and choose the best answer by blackening the circle.

1. What does Mum want to buy?



A.



B.



C.



D.

2. Mum wants to buy a skirt for \_\_\_\_\_.

A. Aunt Maggie

B. Aunt Mandy

C. Aunt Sandy

D. Aunt Sammy

3. Which of the following is Kenny going to buy?



A.

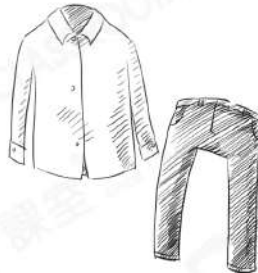

B.

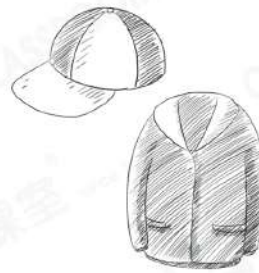

C.



D.

4. What colour is Dad's jacket?

A. purple and white

B. black and purple

C. purple and orange

D. orange and yellow

5. Grandma wants \_\_\_\_\_.

A. a dress

B. a skirt

C. a jacket

D. nothing



# 3 Fun in the Park



**A** Fill in the blanks with the correct words.

see-saw    slide    bench    roundabout  
 swing    pond    sandpit

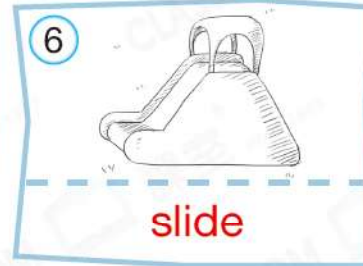
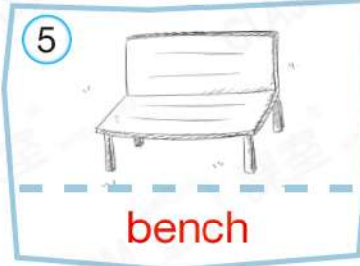
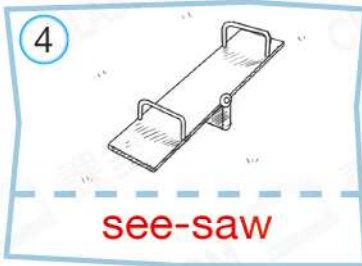
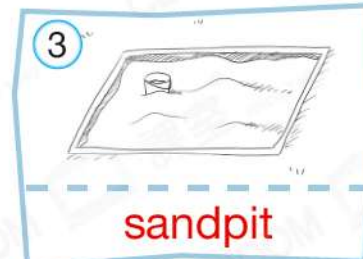
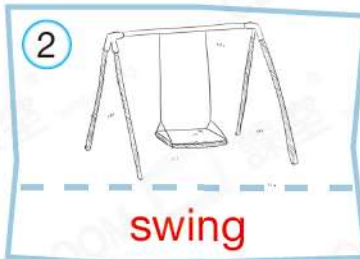
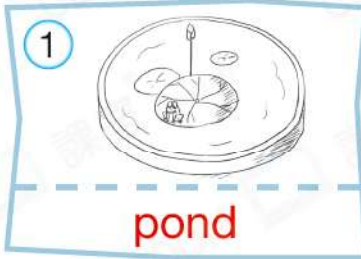

**B** Listen and write the correct letters in the boxes.

A. duck    B. ant    C. butterfly  
 D. caterpillar    E. bee

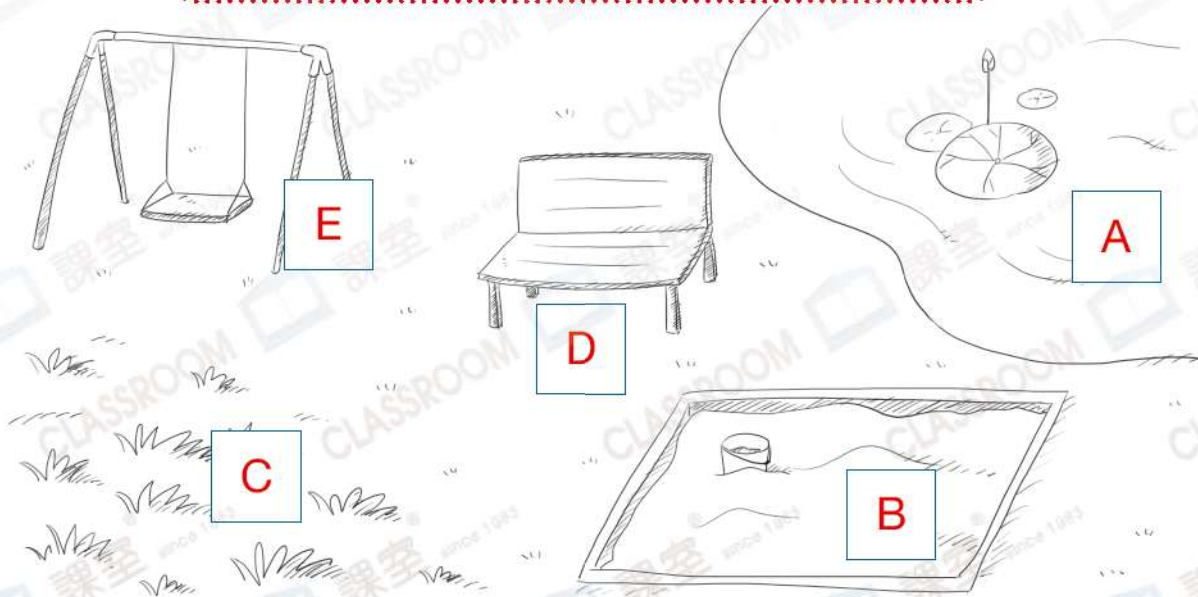

Rate your work:  
(Please circle)











You've scored

Date: \_\_\_\_\_ / 20

Picture Description

10 **C** Listen and write the numbers 1-8 in the correct boxes.

3

 <p>6</p>	 <p>3</p>
 <p>7</p>	 <p>2</p>
 <p>1</p>	 <p>8</p>
 <p>4</p>	 <p>5</p>

Blacken ● the circle for the correct answer.

How does Nancy feel today?

- A. happy     B. sad     C. angry     D. bored



# 4 Lovely Animals



11 **A** Listen and write the correct numbers in the boxes.

1



7

2



15

3



12

4



13

5

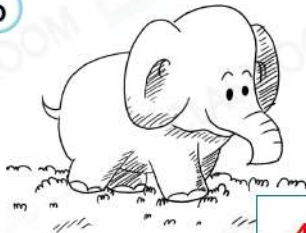

4

6



10

12 **B** Listen and write the correct letters in the circles.

- A. elephants    B. monkeys    C. pandas  
D. hippos    E. lizards

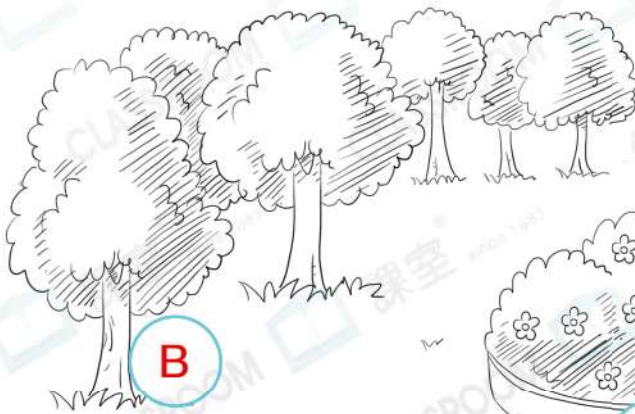

B

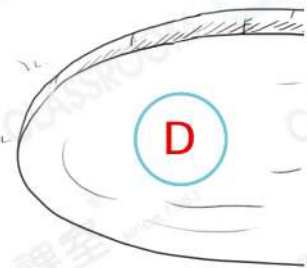

D



C



A

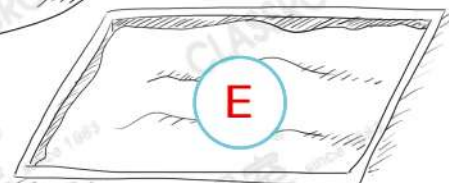

E

Rate your work:  
(Please circle)



You've scored

Date: \_\_\_\_\_





/21

Table

13 **C** Listen and complete the table with the correct words or numbers.

Marking:

Please note that 1 mark will be scored for each correct blank and 0.5 mark will be scored for each correct box, including each correct empty box.

	Julie	Mark	Eric	Susan
Where are they?	near the pond	under the tree	on the grass	near the flowers
		2		10
	2		7	
	4			
		15		9

**Blacken ● the circle for the correct answer.**

What is Susan's favourite animal?

- A. hippo                       B. monkey  
 C. panda                         D. snake

# Upgrade Your Listening

## 2

Listen



14 **A** Listen and circle the words that you hear.

1. cut      **nut**      hut      but
2. run      sun      **bun**      fun
3. **zero**      zoo      sew      salad
4. three      **tree**      free      see
5. strong      wand      **song**      pond

15 **B** Listen and complete the notes.

### Notes about Magic Zoo

1. Where are the monkeys? (*please circle*)



2. What are the monkeys doing? (*please circle*)

eating bananas / **fighting** / playing

3. How many monkeys are there?

14 monkeys

Rate your work:  
(Please circle)



You've scored

Date: \_\_\_\_\_

/13

## Skills for Exam

### Understanding the speaker's feelings

Some questions test your ability to find out how the speaker feels or thinks about something. You have to pay attention to the speaker's voice and tone.



16 **C** Peggy and Gary are in the park. Listen and choose the best answer by blackening the circle.

1. What does Gary want to play?



A.



B.

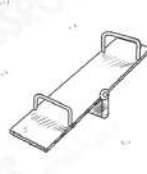

C.

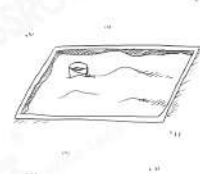

D.

2. What colour is the duck?

A. yellow and brown

B. yellow and white

C. yellow and black

D. yellow and grey

3. Where are the butterflies?

A. on the bench

B. near the bench

C. on the slide

D. near the slide

4. How does Peggy feel?



A.



B.



C.



D.

5. What makes the funny sound?

A. a dog

B. a bird

C. a cow

D. a sheep



# 5

# Look! We Are Having Fun!



**A** Fill in the blanks with the correct words.

playing    talking    sleeping    eating  
 drawing    laughing    drinking

1



drawing

2



drinking

3



sleeping

4



laughing

5

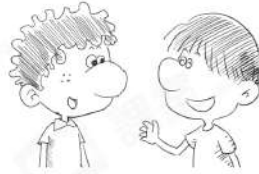

talking

6



playing

17

**B** Listen and circle the correct answers.

Name	What are the children doing?
Jane	1 drawing on her book / chair / <u>desk</u>
2 Ben / <u>Dan</u> / Pam	sleeping
Mandy and Ada	3 playing / <u>talking</u> / laughing
Andy	4 eating a cake / sandwich / <u>hot dog</u>
5 <u>Nick</u> / Rick / Dick	standing on his chair

Rate your work:  
(Please circle)



You've scored

Date: \_\_\_\_\_

/17

Picture Description

18



Listen and write the correct names in the boxes.

5

David Mary Tom Paul Anne

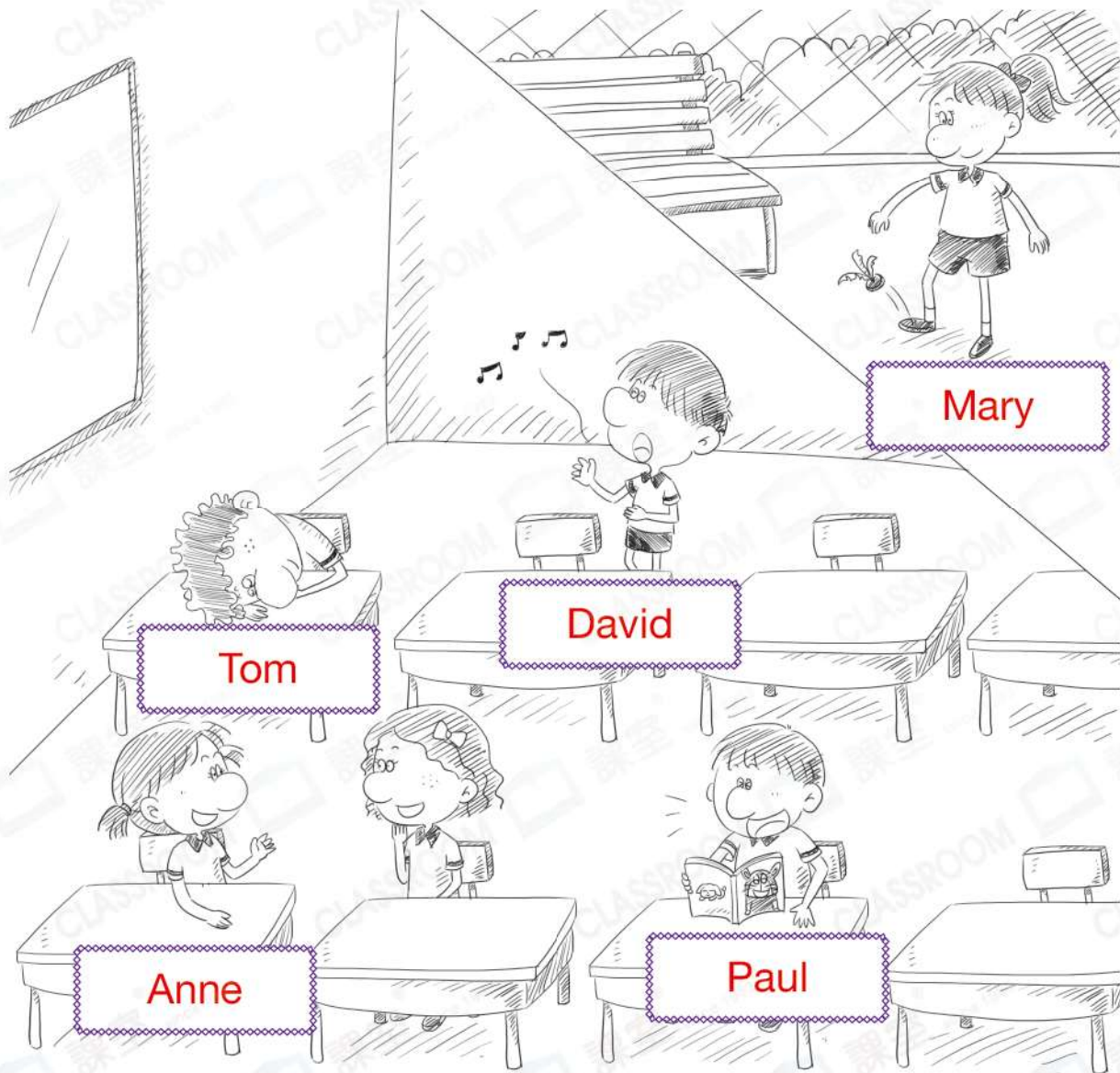

Blacken ● the circle for the correct answer.

What lesson is Miss Lam going to have?

- A. Chinese
- B. English
- C. Maths
- D. Art



# 6 Enjoy Our Free Time



**A** Fill in the blanks with the correct words.

skipping    cycling    swimming    dancing  
hiking    running    ice-skating

1



swimming

2



ice-skating

3



cycling

4



dancing

5



skipping

6



hiking

19

**B** Listen and draw lines to match the pictures.

1



Wendy

2



Sam

3

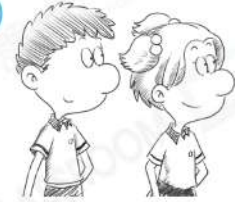

Nick and Vicky

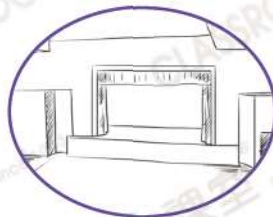

Rate your work:  
(Please circle)



You've scored

Date: \_\_\_\_\_



/15

Table

20

**C** Listen and put a tick '✓' in the correct boxes.

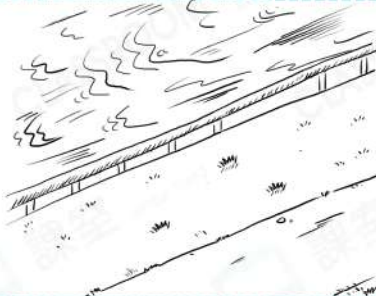
6

	Place	Activity
<b>Penny</b>	<input type="checkbox"/> A. garden <input checked="" type="checkbox"/> B. sports centre <input type="checkbox"/> C. playground	
<b>Ken</b>		<input checked="" type="checkbox"/> A. cycling <input type="checkbox"/> B. singing <input type="checkbox"/> C. running
<b>Carol</b>		<input type="checkbox"/> A. skipping <input checked="" type="checkbox"/> B. flying a kite <input type="checkbox"/> C. hiking
<b>Charlie and Tina</b>	<input type="checkbox"/> A. hall <input checked="" type="checkbox"/> B. garden <input type="checkbox"/> C. playground	<input type="checkbox"/> A. singing <input type="checkbox"/> B. dancing <input checked="" type="checkbox"/> C. drawing

**Blacken ● the circle for the correct answer.**

What time is it now?

A. 8:30 am

B. 12:30 pm

C. 3:30 pm

D. 6:30 pm

# Upgrade Your Listening

## 3



**A** Listen and circle the words that you hear.

- |    |       |        |       |       |
|----|-------|--------|-------|-------|
| 1. | clock | sock   | knock | rock  |
| 2. | cap   | lap    | rap   | tap   |
| 3. | light | bright | night | right |
| 4. | king  | kit    | kick  | kite  |
| 5. | map   | meat   | mean  | man   |

**B** Listen and circle the correct answers.

	Activity	Place
Mon	1 reading / dancing / playing badminton	school hall
Tue	singing	2 activity room / music room / classroom
Wed	3 skipping / drawing / ice-skating	Fun World
Thur	flying a kite	4 hill / park / beach
Fri	making models	5 activity room / art room / classroom

Rate your work:  
(Please circle)



You've scored

Date: \_\_\_\_\_ /15

### Skills for Exam

#### Using personal experiences and knowledge of the world

Some questions test your ability to answer the question based on what you know. Try to relate what the question asks about and the recording to your daily life experiences.



23

**C** Robert and his mum are talking on the phone. Listen and choose the best answer by blackening the circle.

1. What is Mum doing?



A.



B.



C.



D.

2. Who can Mum see in the USA?

A. Aunt Tina

B. Aunt Gina

C. Aunt Minna

D. Aunt Nina

3. Max and Jenny are \_\_\_\_\_.

A. telling jokes

B. laughing

C. talking

D. watching TV

4. Where is Zoe?



A.



B.



C.



D.

5. Mum is coming home on \_\_\_\_\_.

A. 1<sup>st</sup> December

B. 15<sup>th</sup> December

C. 24<sup>th</sup> December

D. 25<sup>th</sup> December



# 7 Our Feelings



**A** Listen and write the correct numbers in the boxes.

a



3

b



2

c



4

d



1

e

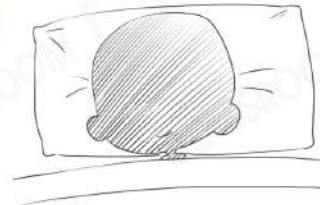

5

**B** Listen and blacken ● the circle for the correct answer.

1. How does Danny feel?



A.



B.



C.



D.

2. Joanne and Danny are buying \_\_\_\_\_.

A. fans

B. chips

C. ice cream

D. cold water

3. What may Danny do when he is home?

A. get some sleep

B. watch TV

C. have a bath

D. do homework

Rate your work:  
(Please circle)



You've scored

Date: \_\_\_\_\_

/17









Table

26



Listen and put a tick '✓' in the correct boxes.

7

	Penny	Mark	Ann	Bobby
hot			✓	
cold	✓			
hungry				✓
thirsty		✓		
bored				
What do the children want?	<input type="checkbox"/>	<input type="checkbox"/>	<input checked="" type="checkbox"/>	<input type="checkbox"/>
				
	<input checked="" type="checkbox"/>	<input checked="" type="checkbox"/>	<input type="checkbox"/>	<input checked="" type="checkbox"/>
				

Marking:

Please note that 1 mark will be scored for the feeling of each person in the table and 0.5 mark will be scored for each correct box of the pictures, including each correct empty box.

Blacken ● the circle for the correct answer.

What is Leo going to do?

- A. get some sleep
- B. watch TV
- C. read comics
- D. play football



# 8 Love My Body



**A** Fill in the blanks with the correct words.

shoulder    mouth    toe  
arm    knee    leg    finger

1

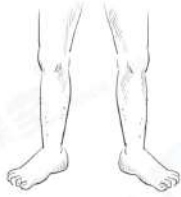

leg

2



toe

3



shoulder

4



mouth

5



finger

6



arm

27

**B** Listen and draw the monster in the space below.

Marking:

Please note that 1 mark will be scored for each body feature of the monster (i.e. eyes, tail, ears, mouth and arms).

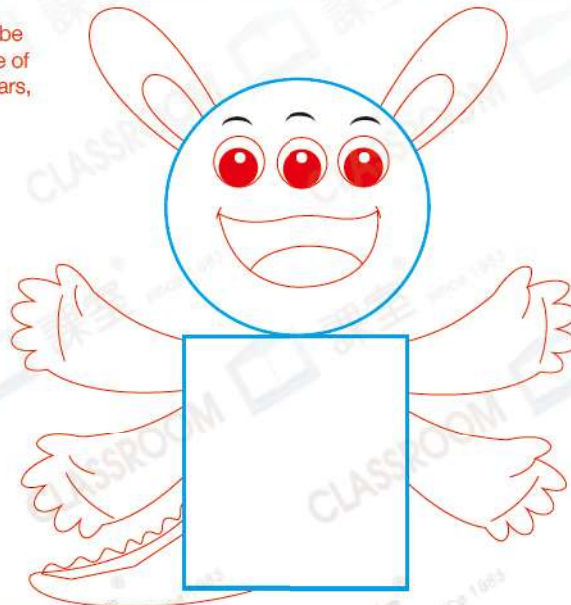

Rate your work:  
(Please circle)



You've scored

Date: \_\_\_\_\_

/20

Picture Description

28 **C** Listen and write the numbers 1-8 in the correct boxes.

8

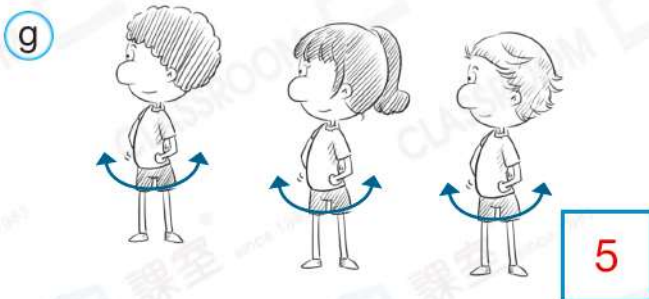
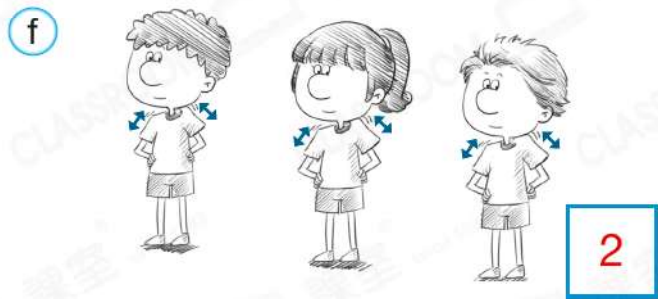
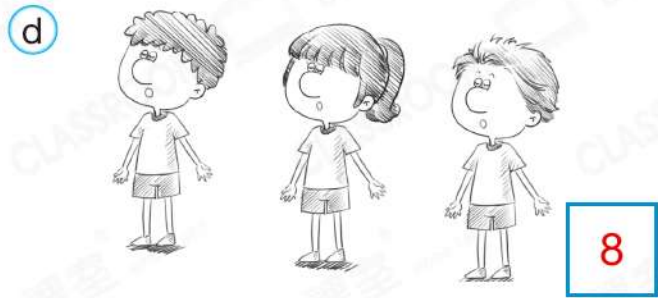
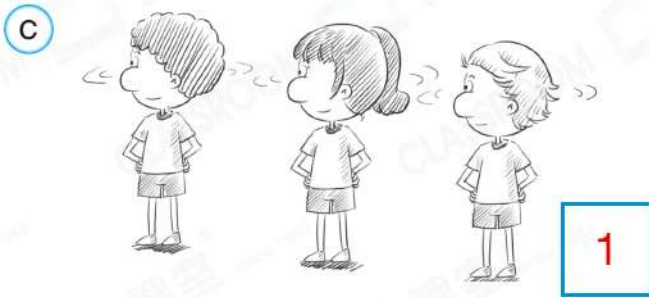

Blacken ● the circle for the correct answer.

Where are the children?

● A. in the playground

○ B. in the classroom

○ C. in the activity room

○ D. in the school hall

# Upgrade Your Listening



29

**A** Listen and circle the words that you hear.

- |         |       |      |      |
|---------|-------|------|------|
| 1. log  | wrong | fog  | frog |
| 2. cat  | cap   | coat | cut  |
| 3. read | need  | feed | seed |
| 4. lamp | leg   | neck | name |
| 5. tail | fail  | boil | mail |

30

**B** Listen and match the pictures with the children's names. Then write the correct letters in the brackets.

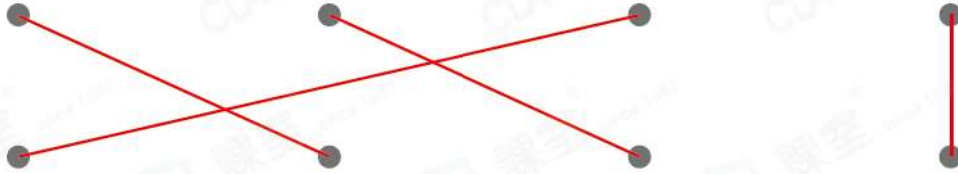

A. Sarah

B. Gary

C. Helen

D. Louis

Who wants the following?



( C )



( B )



( D )



( A )

Rate your work:  
(Please circle)



You've scored

Date: \_\_\_\_\_

/18

31

**C** The children are at a camp. Listen and choose the best answer by blackening the circle.

1. What is Sally doing?



A.



B.



C.



D.

2. Who is hungry?

A. Benny

B. Danny

C. Kenny

D. Lenny

3. Sally says, 'Let's do it.' What does 'it' mean?

A. do puzzles

B. play card games

C. draw pictures

D. read comics

4. What is Mike drinking?

A. fruit juice

B. water

C. milk

D. soft drink

5. What do Sally and Mike like about the camp?

A. They can cook.

B. They can do the dishes.

C. They can play many games.

D. They can sing.



32

## A Listen and colour the children's favourite toys.

1

Brenda's toys

(pink dress, brown hair)



2

Roy's toys

(green and brown)

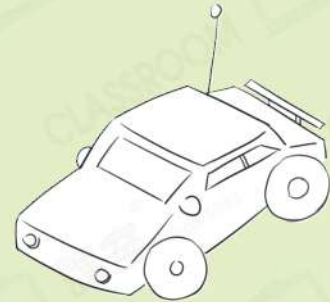
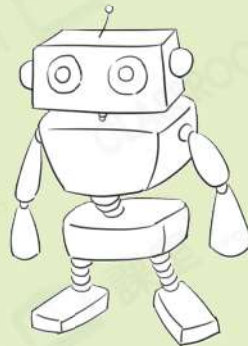
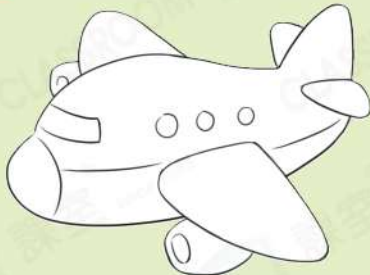

3

Jason's toys

(red)

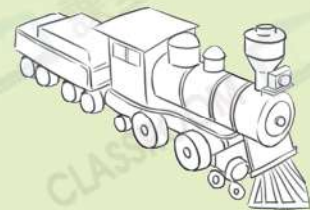
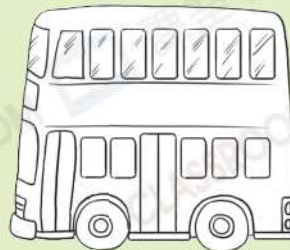

Rate your work:  
(Please circle)



You've scored

Date: \_\_\_\_\_

/11

33

**B** Listen and write the correct letters in the boxes.

A. Mum's    B. Dad's    C. Sam's  
D. Tammy's    E. Grandpa's



C



D



D



E



E



B



A



B



34 **A** Listen and circle the correct pictures.

1

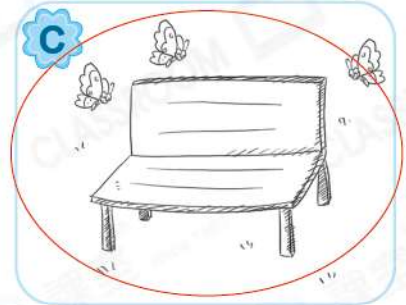
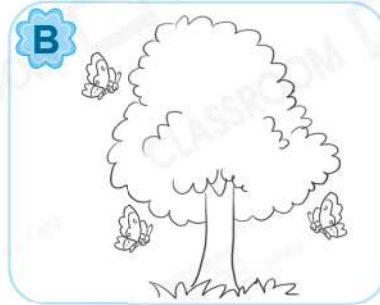

2

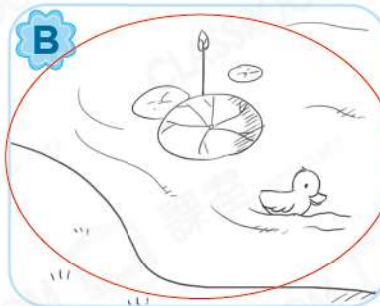
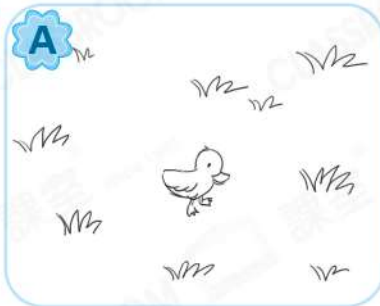

3

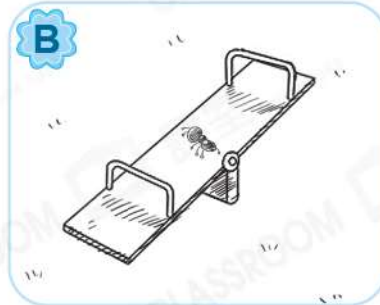
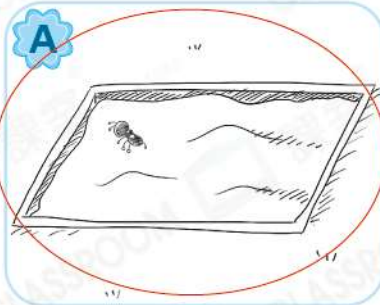

4

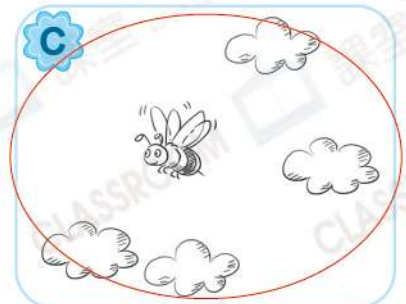
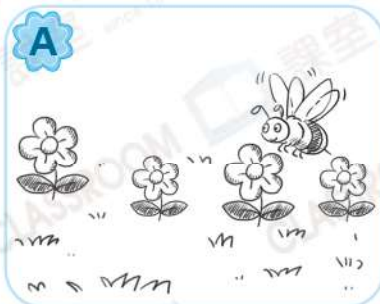

Rate your work:  
(Please circle)



You've scored

Date: \_\_\_\_\_

/10

**B** Listen and write the correct letters in the boxes or numbers in the circles.

A



B



C



D



E



F

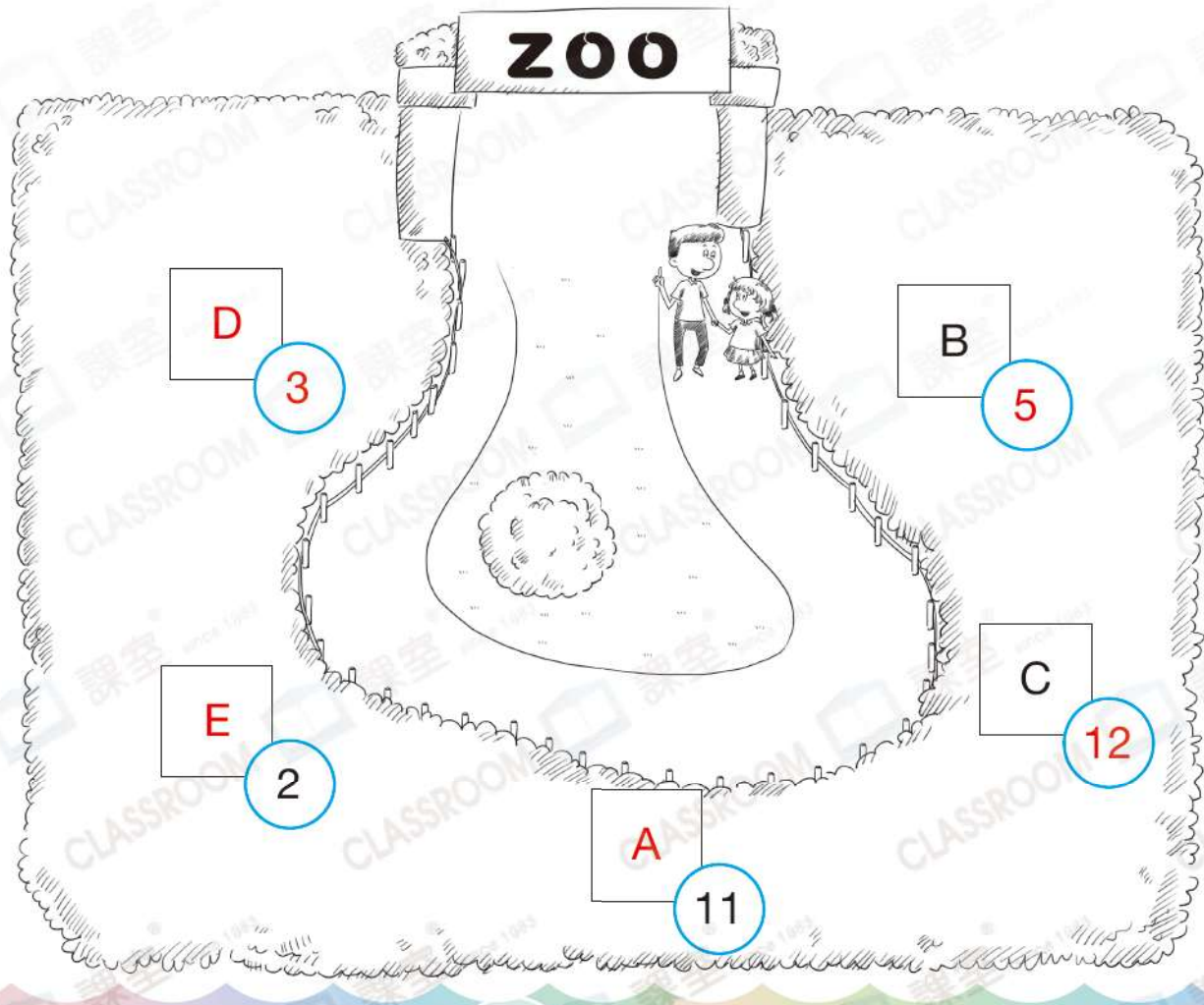



36 **A** Listen and write the numbers 1-8 in the correct boxes.

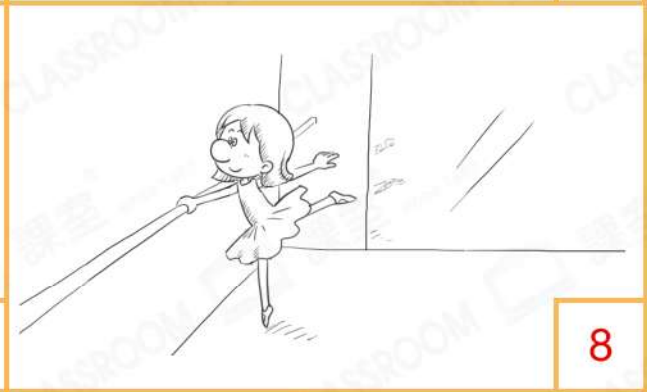

Rate your work:  
(Please circle)







You've scored

Date: \_\_\_\_\_

/14

37

**B** Listen and complete the table.

Name				
Feeling	Julie	Fred	Carmen	Dicky
hungry			✓	
thirsty				✓
hot	✓			
cold				
bored		✓		
Let's ... (Write the letters)	C	A	D	B

A. play games

B. have soft drinks

C. have ice lollies

D. buy some biscuits

E. eat some bread

F. buy some hot drinks

In a park



Our clothes

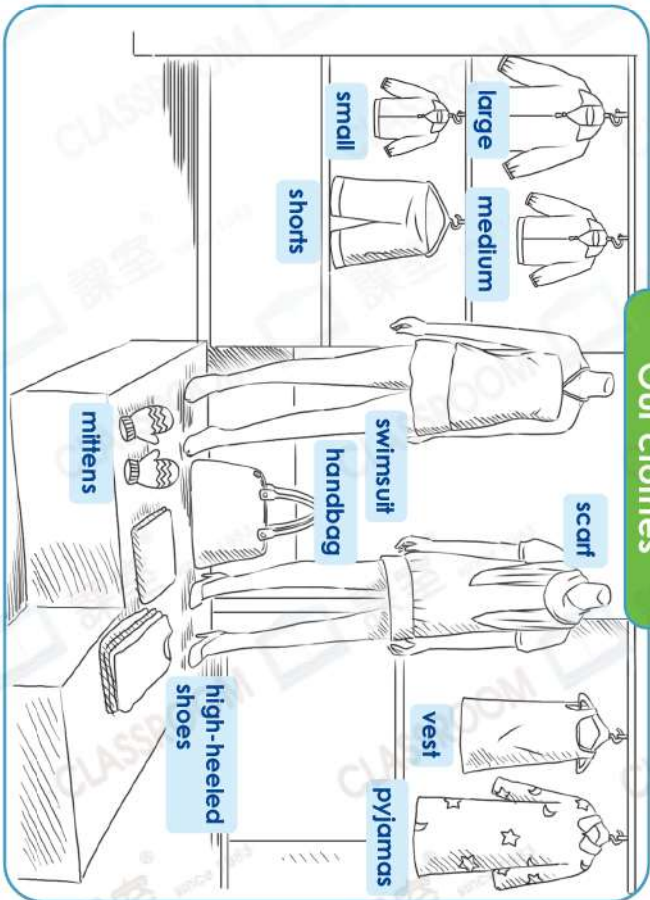

Our free time

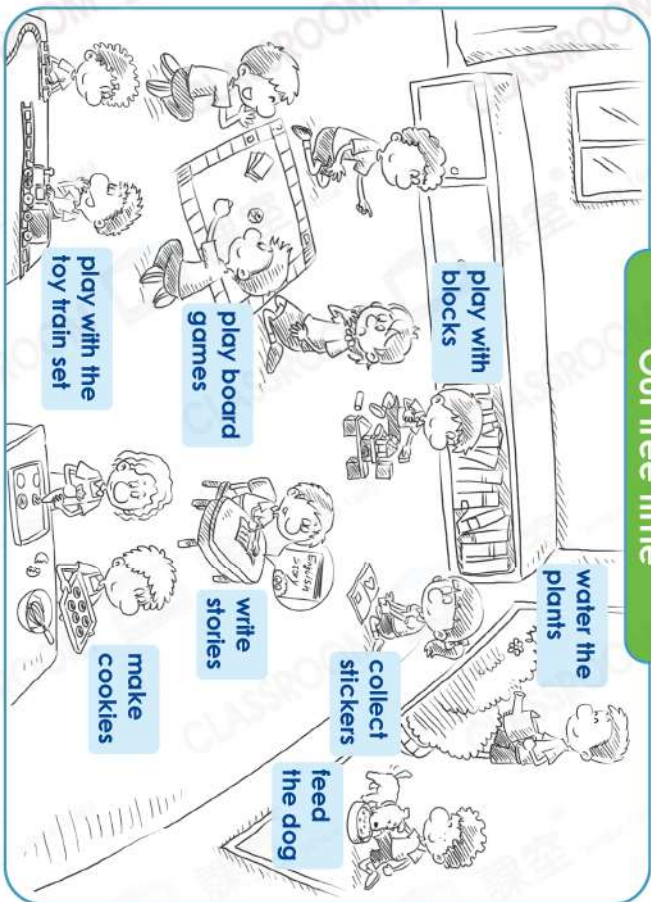

My body

